



MOBILE COMPUTER M3 UL20 Series

APPLICATIONS

- Logistics Applications
- Warehouse Management
- Inventory Management
- Supply Chain Management
- Retail Markets

FEATURES

- RFID HF | NFC Reader
- 2D Barcode Scanner
- Android 8.1 / 9.0
- 2.2 GHz Octacore CPU
- Alpha-Numeric Keypad
- 16 Megapixel Camera
- WWAN | WLAN | Bluetooth
- IP67 Protection Class
- Gorilla® Glass 5" Display
- Integrated Sensors
- 2 SIM Slots

RFID OPTION

- RFID HF | NFC (ISO 14443 A / B, ISO 15693)

PRODUCT DESCRIPTION

The M3 Mobile UL20 series is the next generation of the leading handheld devices for mobile data capturing in the industrial and logistical applications. Mobile data collection made easy with the integrated alpha-numeric keypad with 28-key, 53-key or 35-key.

M3 UL20 offers well-proven technology in the field of portable mobile data collection that allows you to meet the latest barcode reading technologies, modern user interfaces and the category of new business applications on the Android 8.1 operating system.

An integrated angled scanner with 25° helps comfortable aiming. The integrated RFID HF | NFC reader valid identifies RFID tags. UL20 Series is equipped with a long range scanner. It is able to read barcodes up to 21.4 meters. WLAN and Bluetooth enables the wireless transfer of data to your computer, so that the scanned information immediately show up in your system.

M3 UL20 is usable in harsh environments with water or dust immersion thanks to the IP67 protection class. It can work from -30 °C up to 60 °C with automatic sensor to control temperature of screen and scanning window.

The UL20 series comes with a wide range of accessories like vehicle cradle, trigger handle or wireless plate. These are adapted to a wide range of applications in warehouse or inventory management or parcel delivery.

We deliver the M3 UL20 series with an software development kit for android systems. This supports the programming languages: C++ and C# command protocol. Using the SDK simplifies the connection to your existing systems.



TECHNICAL DATA

PHYSICAL CHARACTERISTICS	
Dimensions	88.7 × 244.75 × 46.19 mm
Weight	530 g (2D Scanner) 580 g (Long-range Scanner)
Display	Gorilla Glass 5-inch FHD (Full High Definition) (1.920 × 1.080) outdoor viewable, Frost-free (UL20F)
Battery	Rechargeable li-ion Polymer 3.6 V, 6,700 mAh, designed for high-performance in low temperatures (UL20F)
Interface	USB 2.0 Client (C type) USB 2.0 Host (A type)
Camera	Rear: 16.0 Megapixel Autofocus with LED Flash
Keypads	35-Key Alpha Numeric+Function keypad and 6 Side key, Optional: 28-Key, 53-Key

PERFORMANCE CHARACTERISTICS			
	UL20X	UL20W	UL20F
CPU	2.2 GHz Octa-core processor	2.0 GHz Octa-core processor	2.2 GHz Octa-core processor
RAM ROM	4 GB RAM 64 GB ROM	2 GB RAM 16 GB ROM	4 GB RAM 64 GB ROM
SIM SAM	2 SIM	-	-
Memory	MicroSD		

USER ENVIRONMENT			
	UL20X	UL20W	UL20F
Operating Temperature	-20 °C to +60 °C		-30 °C to +60 °C
Storage Temperature	-30 °C to +80 °C		-40 °C to +80 °C
Humidity	5% RH to 95% RH (non-condensing)		Condensing (Condensation-free using internal heaters)
Drop Specifications	2 meters 2,000 Cycle / 1.0 m (4,000 drops)		
Protection Class	IP67		
Heater	-	-	Scanning window heater, LCD heater
Sensors	Accelerometer, Gyro, Ambient light, Proximity, E-compass, Magnetic		

PROGRAMMING ENVIRONMENT	
Operating System	Android 8.1 / 9.0
SDK	Software Development Kit
Language	Javascript
Environment	Android Studio or Eclipse

COMMUNICATION	
WLAN	2.4 GHz/5.0 GHz Dual Frequency, IEEE 802.11 a/b/g/n/ac
WWAN	<p>► 3G WCDMA B1/2100;B2/1900;B5/850;B8/900; CDMA2000/EVDO 3G:TD/SCDMA</p> <p>► 4G LTE FDD-LTE: B1/2100;B3/1800;B7/2600;B20/800; TDD-LTE: B38/B39/B40/B41</p> <p>► GSM B5/850;B8/900;B3/1800;B2/1900</p>
WPAN	Bluetooth Class II 4.1 LE Max E.I.,R.Power :8.837dBm
GPS	A-GPS, GLONASS, Beidou, Galileo
Security	WEP, WPA, WPA2, TKIP, AES, EAPFAST, EAP-TLS, EAP-TTLS, PEAP-GTC, PEAP- TLS, PEAP-MSCHAPv2, LEAP, CCXv4
NFC	ISO 1443 A/B, ISO 15693, Mifare, P2P Max Power: -13.75dBuA/m

2D BARCODE IMAGER	
Honeywell N6603	
Symbologies	Linear: UPC/EAN/JAN, GS1 DataBar, Code 39, Code 128, Code 32, Code 93, Codabar/NW7, Interleaved 2 of 5, Code 2 of 5, Matrix 2 of 5, MSI, Telepen, Trioptic, China Post, 2D Stacked: PDF417, MicroPDF417, GS1 Composite 2D Matrix: Aztec Code, Data Matrix, QR Code, Micro QR Code, MaxiCode, Han Xin Code Postal: Intelligent Mail Barcode, Postal-4i, Australian Post, British Post, Canadian Post, Japanese Post, Netherlands (KIX) Post, Postnet, Planet Code OCR Option: OCR-A, OCR-B, E13B (MICR)

RFID HF READER	
Frequency	13.56 MHz
Protocol	ISO 14443A, ISO 15693, NFC-IP1, NFC-IP2
Reading Range	up to 1.5 m

SUPPORTED STANDARDS TAGS	
ISO 14443 A and compatible	<p>Read/write: MIFARE® DESFire® EV1 2K / 4K / 8K, MIFARE® Classic Mini / 1K /4K, MIFARE Ultralight®, MIFARE Ultralight® C, MIFARE® Plus S / X, MIFARE® Pro X, NTAG 21x</p> <p>Read UID only: Read UID only of all other ISO14443A RFID tags</p>
ISO 14443 B and compatible	SRI4K, SR1X4K, AT88RF020, 66CL160S, SR176
ISO 15693 and compatible	EM4135, EM4043, EM4x33, EM4x35, I-Code SLI / SLIX, M24LR16/64, TI Tag-it HF-I, SRF55Vxx (my-d vicinity)





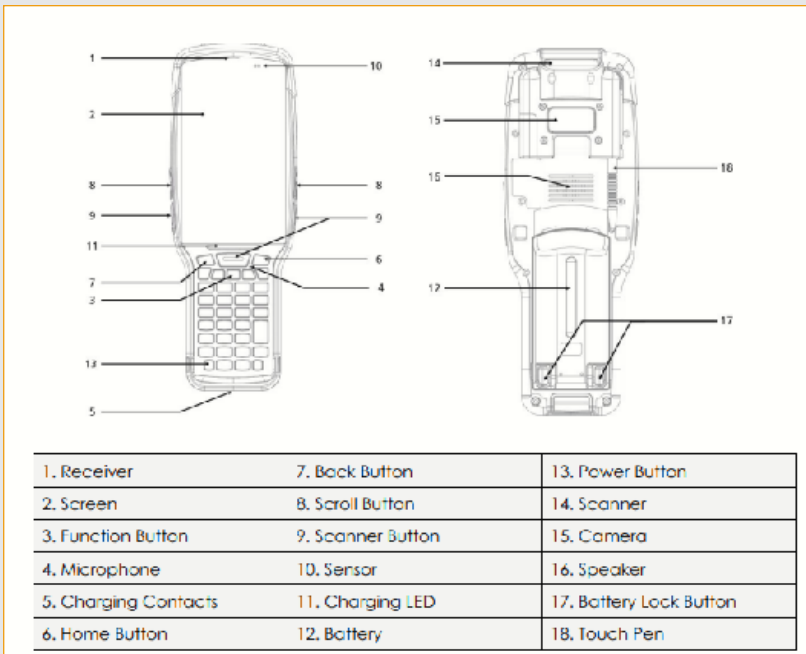

PRODUCT PICTURES



FUNCTIONS



ACCESSORIES

		
Charging Cradle	8 Slot Cradle	Pistol Grip (Trigger)
		
Vehicle or Forklift Cradle	Wire Plate	Hand Strap
		
Spare Battery	USB Cable	Stylus Pen

ORDER CODES

VERSIONS	ORDER CODES
M3 UL20X	R-HH-M3-UL20-X
M3 UL20W	R-HH-M3-UL20-W
M3 UL20F	R-HH-M3-UL20-F

ACCESSORIES	ORDER CODES
Charging Cradle	R-HH-M3-UL20-DTC
8-Slot Cradle	R-HH-M3-UL20-8SC
Pistol Grip (Trigger)	R-HH-M3-UL20-PG
Vehicle or Forklift Cradle	R-HH-M3-UL20-VC
Wire Plate	R-HH-M3-UL20-WP
Hand Strap	R-HH-M3-UL20-HST
Spare Battery	R-HH-M3-UL20-PS
USB Cable	R-HH-M3-UL20-PSC
Stylus Pen	R-HH-M3-UL20-SP

iDTRONIC GmbH
Ludwig-Reichling-Straße 4
67059 Ludwigshafen
GERMANY

Phone +49 (0) 621 66 90 09 4-0
Fax +49 (0) 621 66 90 09 4-9
E-Mail: info@idtronic-rfid.com
Web: idtronic-rfid.com

For further information & prices, please contact info@idtronic-rfid.com

Subject to alteration without prior notice
©2021 iDTRONIC GmbH